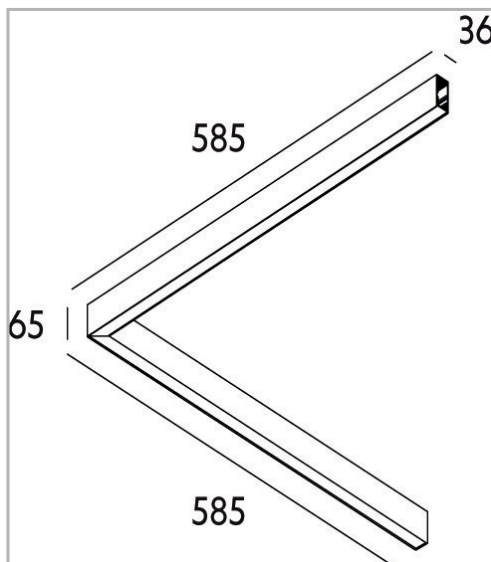

Eclairage > Luminaires > Plafonnier > Suspendu > LEADER P/S

DÉSIGNATION ARTICLE : [PLAFONNIER LEADER P/S OP BLANC 20W 1900LM 3000K](#)

PHOTOS ET SCHÉMAS

[+ DE VISUELS SUR WWW.SERMES.FR](http://www.sermes.fr)

CARACTÉRISTIQUES DÉTAILLÉES

Code article	31264132
EAN 13	3262571172419
IK	08
Flux lumineux	1900 Lm
MacAdam	2
IP	20
Détecteur	NON
Gradation	ON/OFF
Intérieur ou extérieur	intérieur
Poids article	1,700 Kg

CARACTÉRISTIQUES GÉNÉRALES

LAMDA FIRST
Non

TÉLÉCHARGEMENT



[VISUELS \(1.512 MO\)](#)

